

# HSF

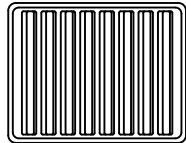

No. 1: 产品装入真空盒内 (XXPCS/盒)  
SB-31AB: 235\*185\*12mm真空盒

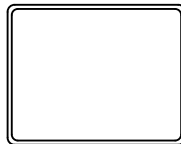

No. 2: 盖上盒盖

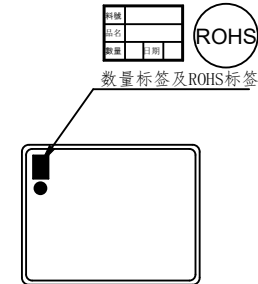

No. 3: 贴真空盒标签

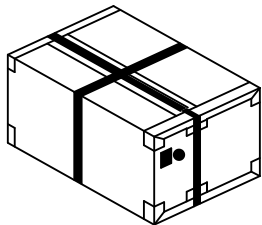

No. 6: 打包装带

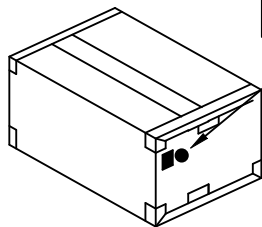

No. 5: 封箱及贴纸箱标签

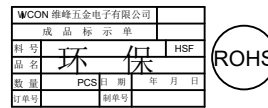

贴外箱标签及ROHS标签

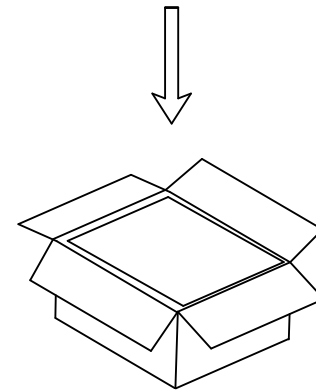

No. 4: 真空盒装入纸箱 (20盒/箱)  
纸箱上下加入纸护板  
CTN-05K (双坑K=K, 40\*26.5\*16.5CM)

### 说明:

1. 产品如图所示型态放入真空盒
2. 注意各标签样式. 位置及方向的一致性;
3. 打外箱包装带时需注意, 打为十字型.

变更  
记录

						零件图	颜色		SCALE	1:1	<b>WCON</b> WCON Hardware Electronics Co.,Ltd	料号 PART NO. 6220-XXFBXXX01
						X.	COLOR		UNIT	mm		
						X.X	材质		SIZE	A4		
						X.XX	DESING	颜亚芳 08/05/10	SHEET	1/1		
						X.XXX	CHECK		PROJ.			
A0	08/05/10	NEW				Angle	核准				品名 TITLE:	D-Sub Female XXP 2排 焊线式, 带后螺母
版次 REV	日期 DATE	变更说明 MODIFICATION DESCRIPTION	变更 CHANGE	核准 APPROVE		X.	核准 APPROVE					
						DIM	TOL					